

s.r.l. GORLA
MORSETTERIE
MILANO

UFFICIO TECNICO

MORSETTO
CON SERRAGGIO A 2 BULLONI
PER COND. CU AFFIANCATI
SEZ. 10 - 25 mmq

DIS. N. LR2578UN

SCALA 1:1

DISEGNATO BORGHI DATA 09.12.75

APPROVATO U.G. DATA 09.12.75

N.	DATA	MODIFICHE	DIS.	APPROVATO
1	01.12.03	DISEGNATO A CAD	M.G.	U.G.

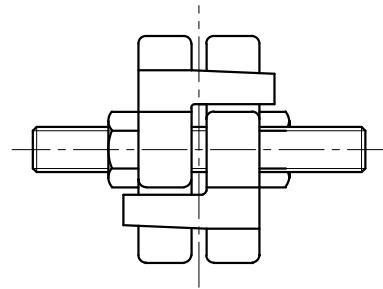
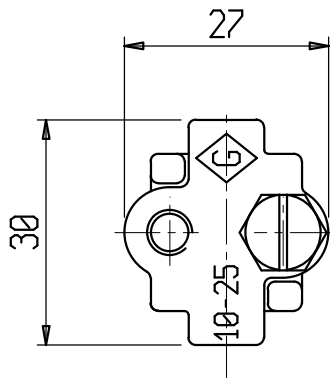
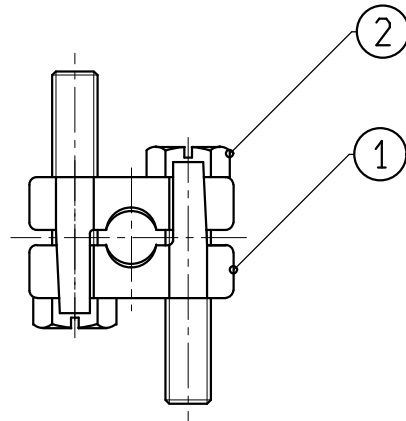

2	VITE TE TAGLIO CACC. M6x30	5927INO	2	ACC. INOX X5CrNi1810 UNI EN 10088	
1	CORPO DEL MORSETTO	LR 2584	2	CU AL Fe 2-C UNI EN 1982	
POS.	DENOMINAZIONE	N° DISEGNO	N° PEZZI	MATERIALE	NOTE